



1059, boulevard des Entreprises Ouest
Terrebonne, QC Canada J6Y 1V2
Tel 450-628-1006 1.800.783.6883
Fax 450-628-7801 1.888.783.6883
www.plasticase.com

CUBED FOAM INSERT

910_NANUK

00910FV_NANUK

p.00

PROJECT

PRODUCT

DWG ID

STATUS

YOUR SIGNATURE IS REQUIRED FOR APPROVAL BEFORE ANY RELEASE OF PRODUCTION DRAWINGS

IP

SIGNATURE

DATE

DESCRIPTION CHANG.

DATE

INIT

ASSEMBLY

LID EGGSHELL

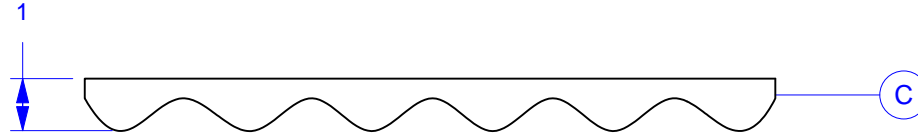

BASE TRAY

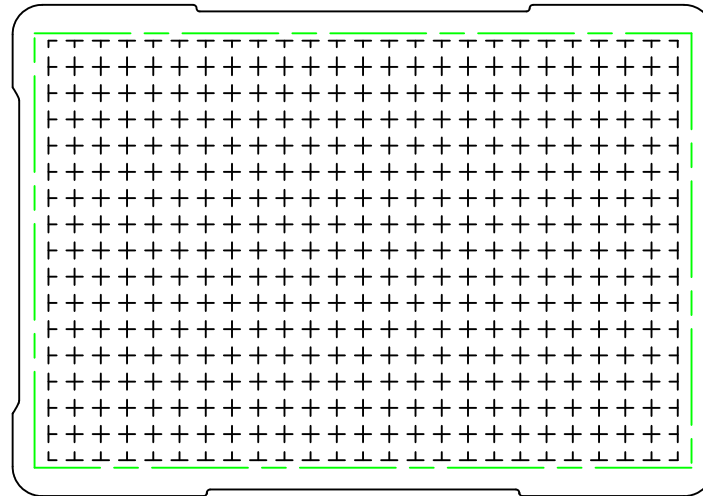

BASE TRAY - ELEVATION

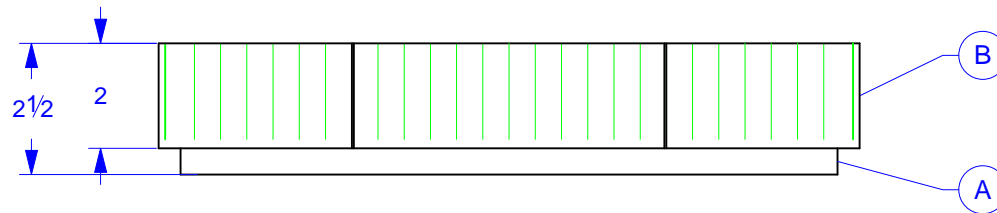

GLUED TOP BASE VELCRO XTRA
SILKSCREEN PRINT PLAIN
LABEL CUSTOM STD NONE
BOX PRINT PLAIN **BAG** PRINT PLAIN
QUANTITY 250, 500
COLOR -

TOLERANCES
 CUTOUTS +/- 1/16
 OVERALL FOAM THICKNESS & CAVITY DEPTHS +/- 1/8



FOAM DENSITY MAY VARY
 DIMENSIONS ARE IN INCHES UNLESS OTHERWISE SPECIFIED

THE INFORMATION CONTAINED IN THIS DRAWING IS THE SOLE AND EXCLUSIVE PROPERTY OF PLASTICASE INC.
 ANY REPRODUCTION IN PART OR WHOLE WITHOUT THE WRITTEN PERMISSION OF PLASTICASE INC. IS PROHIBITED

TO FIT
SCALE

AS REQUESTED
CONCEPT

Frank Vitiello
REPRESENTATIVE

Vanessa Moscato
DESIGNER

2012.08.21
DATE INIT

1/3

LAYOUT

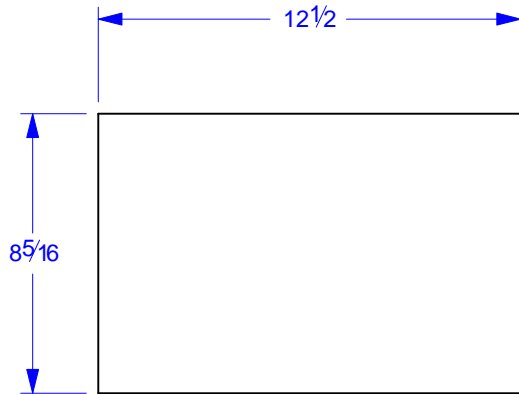

A

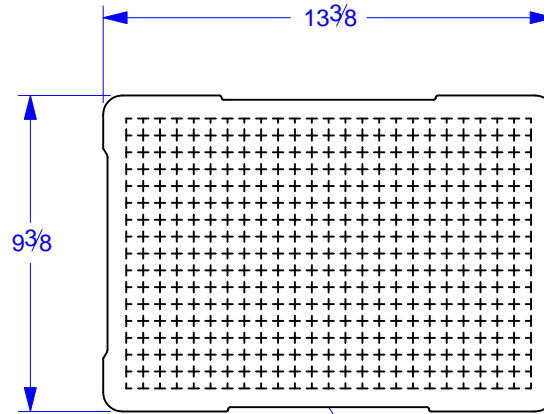

B

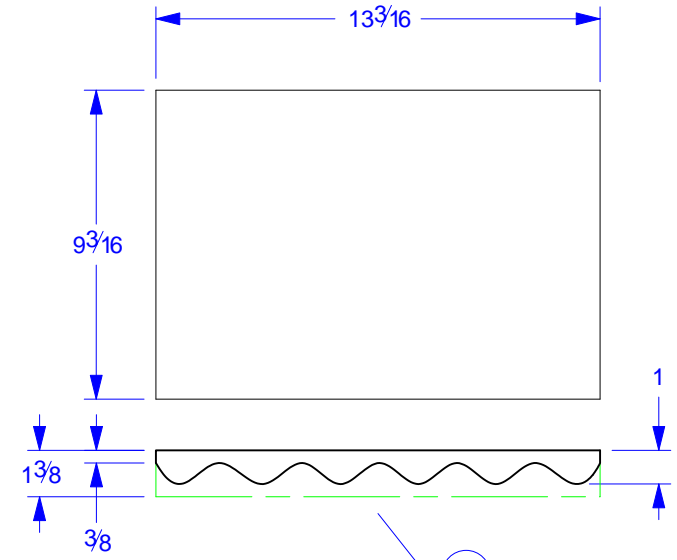

C

PUF 1.5 BLACK 1/2" THICK		
MATERIAL		
-	42"	1
DETAILS	LINEAR IN	QTY

PUF 1.5 BLACK 2" THICK		
MATERIAL		
-	298"	1
DETAILS	LINEAR IN	QTY

PUF 1.5 BLACK CV 1 3/8" THICK		
3/8" BASE		
MATERIAL		
-	-"	1
DETAILS	LINEAR IN	QTY

FOAM DENSITY MAY VARY
 DIMENSIONS ARE IN INCHES UNLESS OTHERWISE SPECIFIED

DETAILS

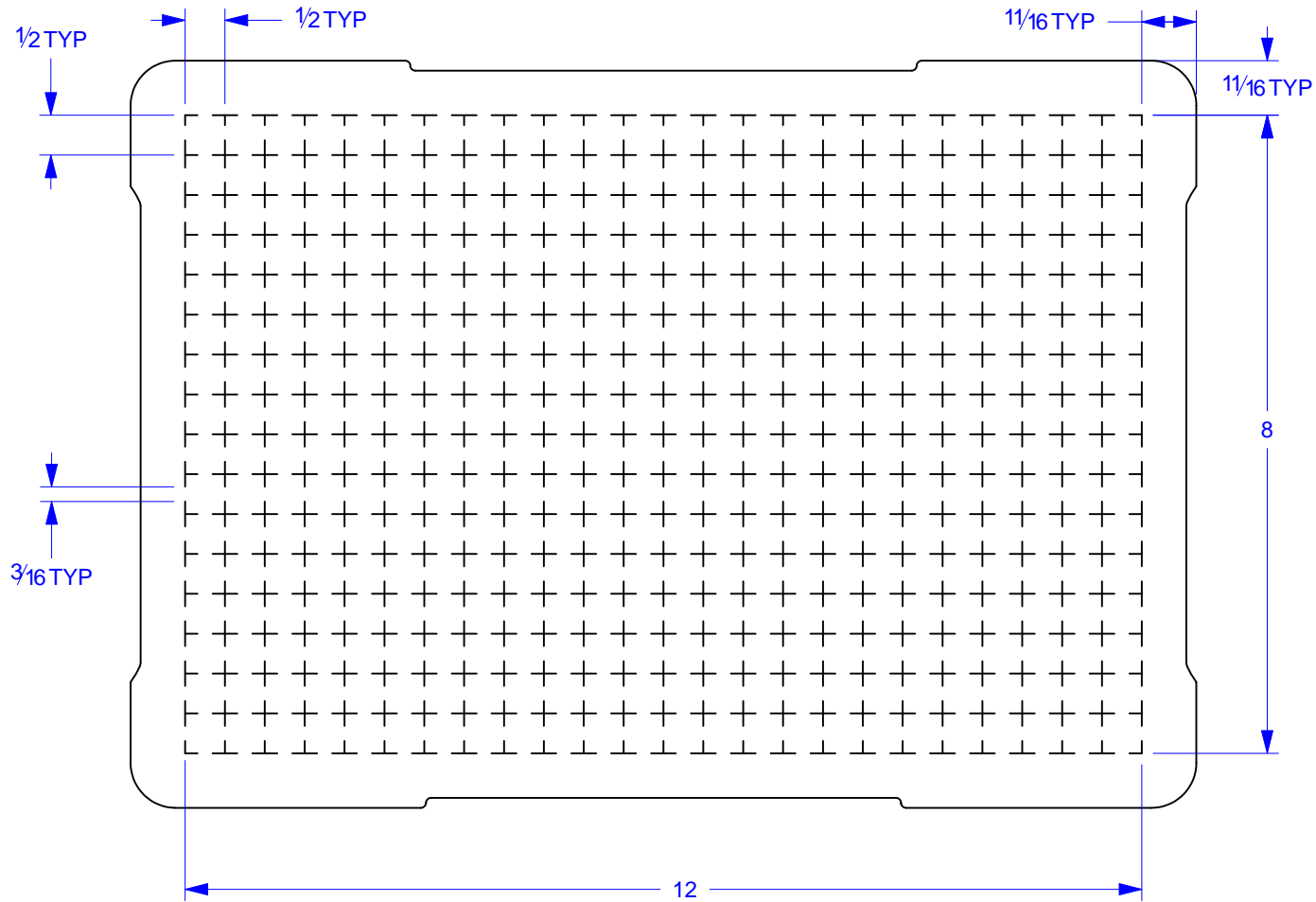

FOAM DENSITY MAY VARY
 DIMENSIONS ARE IN INCHES UNLESS OTHERWISE SPECIFIED