



1059, boulevard des Entreprises Ouest
 Terrebonne, QC Canada J6Y 1V2
 Tel 450-628-1006 1.800.783.6883
 Fax 450-628-7801 1.888.783.6883
 www.plasticase.com

INSERT

PROJECT

NANUK_980

PRODUCT

980_NANUK_Cube foam pdf

DWG ID **980-FOAM**

STATUS

YOUR SIGNATURE IS REQUIRED FOR APPROVAL BEFORE ANY RELEASE OF PRODUCTION DRAWINGS

SIGNATURE

DATE

TOLERANCES

CUTOUTS +/- 1/16

OVERALL FOAM THICKNESS & CAVITY DEPTHS +/- 1/8

GLUED TO CASE TOP BASE VELCRO EXTRA

REVISIONS

REV.	DESCRIPTION	DATE	INIT
------	-------------	------	------

CV STANDARD

LID TRAY

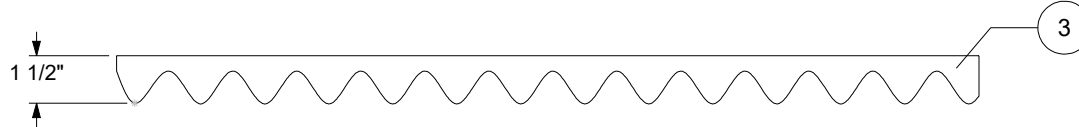

BASE TRAY

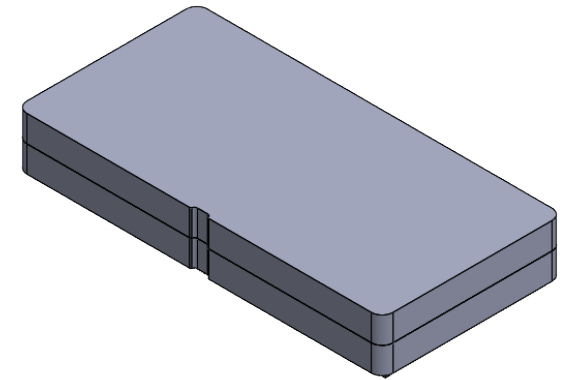
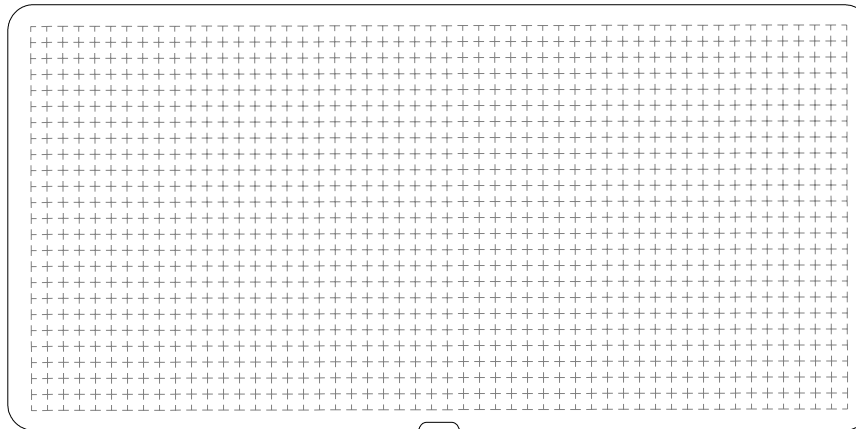

BASE TRAY - ELEVATION

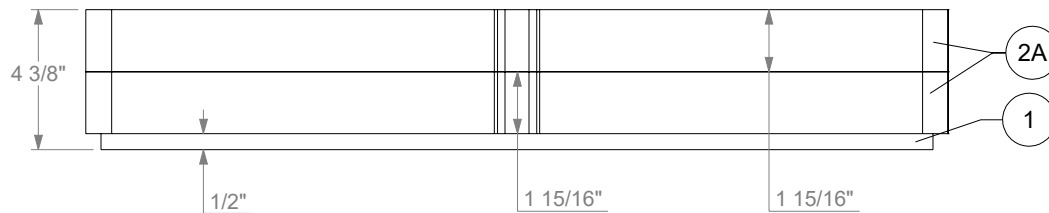

!! LOOSE !!



FOAM DENSITY MAY VARY. DIMENSIONS ARE IN INCHES UNLESS OTHERWISE SPECIFIED

PROPRIETARY AND CONFIDENTIAL

THE INFORMATION CONTAINED IN THIS DRAWING IS THE SOLE & EXCLUSIVE PROPERTY OF PLASTICASE INC. ANY REPRODUCTION IN PART OR WHOLE WITHOUT THE WRITTEN PERMISSION OF PLASTICASE INC. IS PROHIBITED.

DO NOT SCALE DRAWING
 SHEET SCALE 1:6

Frank Vitiello
 REPRESENTATIVE

David Vidal
 DESIGNER

2023-01-25
 DATE

INSERT

PROJECT

NANUK_980

PRODUCT

980_NANUK_Cube foam pdf

DWG ID

STATUS

YOUR SIGNATURE IS REQUIRED FOR APPROVAL BEFORE ANY RELEASE OF PRODUCTION DRAWINGS

TOLERANCES

CUTOUTS +/- 1/16

OVERALL FOAM THICKNESS & CAVITY DEPTHS +/- 1/8

SIGNATURE

DATE

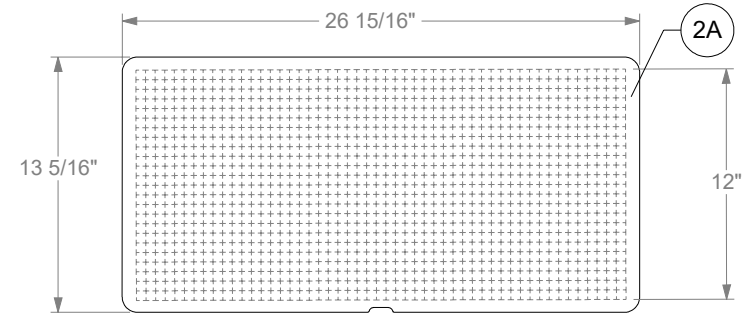
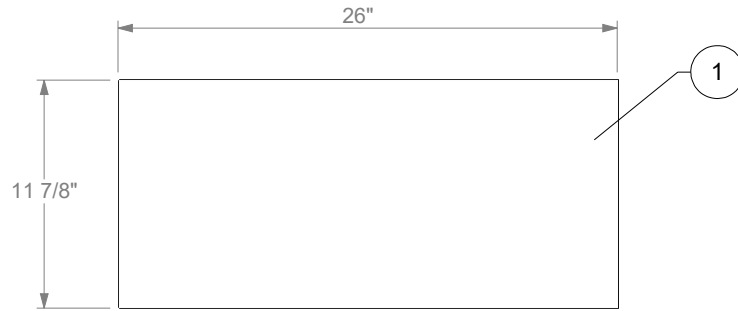

PUF P150-55 Noir	1
Material	Qty

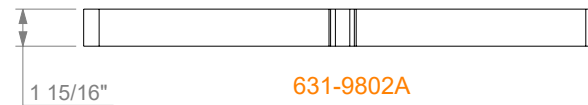

PUF P150-55 Noir	2
Material	Qty

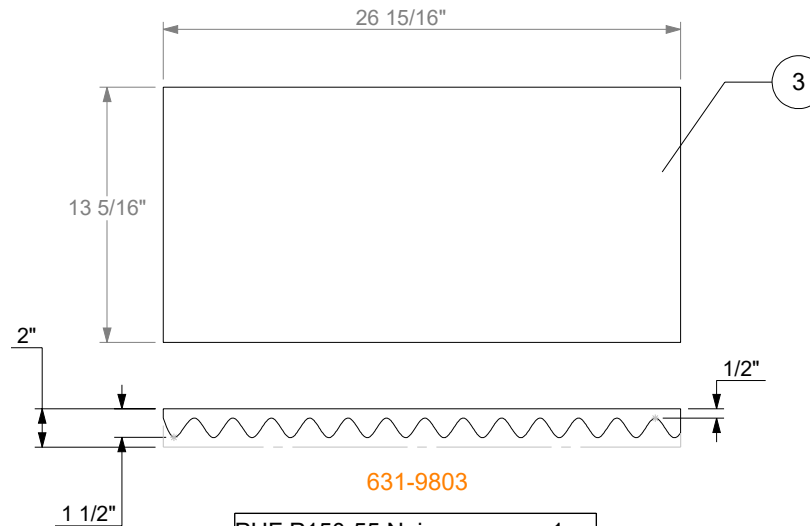

PUF P150-55 Noir	1
Material	Qty

FOAM DENSITY MAY VARY. DIMENSIONS ARE IN INCHES UNLESS OTHERWISE SPECIFIED

PROPRIETARY AND CONFIDENTIAL

THE INFORMATION CONTAINED IN THIS DRAWING IS THE SOLE & EXCLUSIVE PROPERTY OF PLASTICASE INC. ANY REPRODUCTION IN PART OR WHOLE WITHOUT THE WRITTEN PERMISSION OF PLASTICASE INC. IS PROHIBITED.

DO NOT SCALE DRAWING
 SHEET SCALE 1:10

Frank Vitiello
 REPRESENTATIVE

David Vidal
 DESIGNER

2023-01-25
 DATE



1059, boulevard des Entreprises Ouest
 Terrebonne, QC Canada J6Y 1V2
 Tel 450-628-1006 1.800.783.6883
 Fax 450-628-7801 1.888.783.6883
 www.plasticase.com

INSERT

PROJECT

NANUK_980

PRODUCT

980_NANUK_Cube foam pdf

DWG ID

STATUS

YOUR SIGNATURE IS REQUIRED FOR APPROVAL BEFORE ANY RELEASE OF PRODUCTION DRAWINGS

SIGNATURE

DATE

TOLERANCES

CUTOUTS +/- 1/16

OVERALL FOAM THICKNESS & CAVITY DEPTHS +/- 1/8

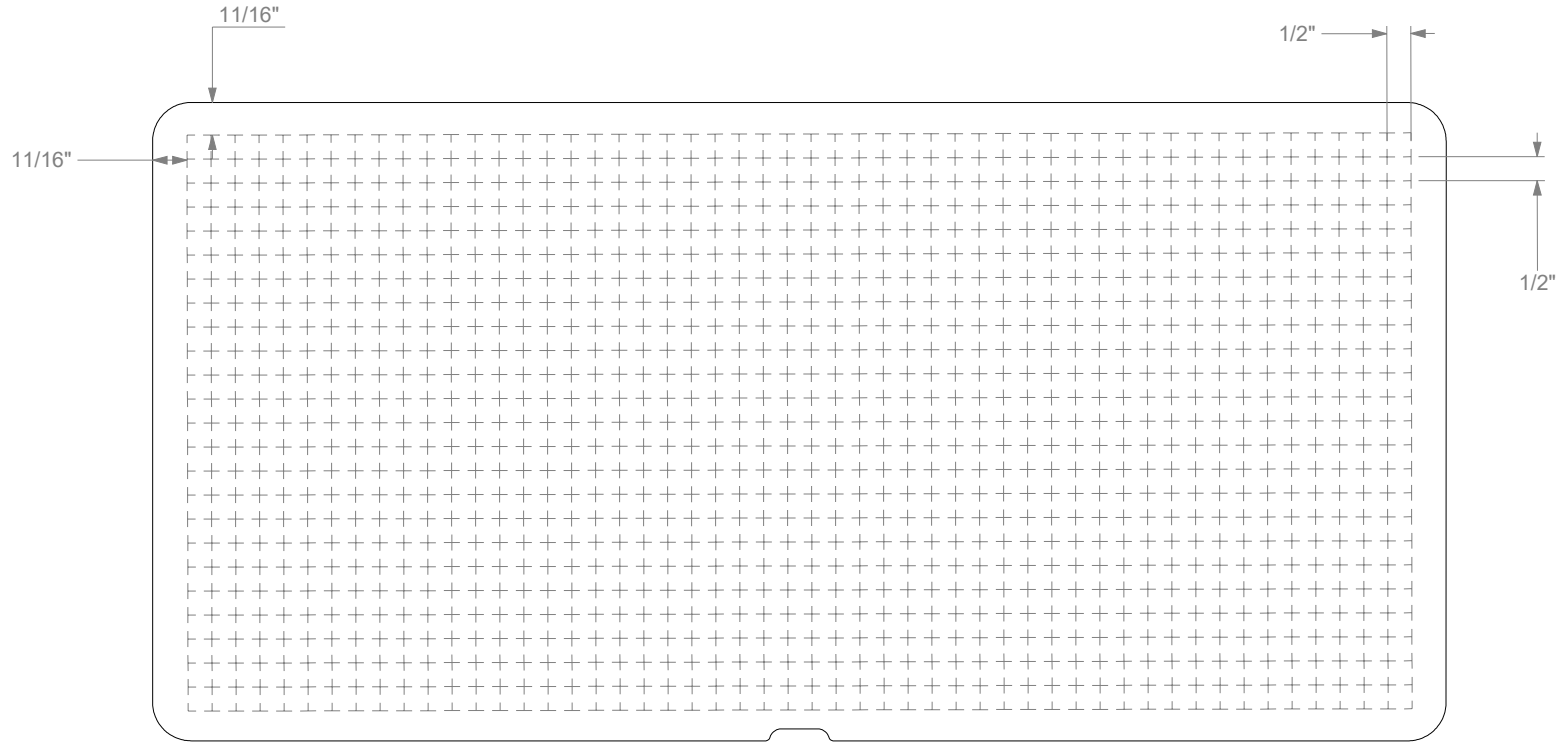

FOAM DENSITY MAY VARY
 DIMENSIONS ARE IN INCHES UNLESS OTHERWISE SPECIFIED

PROPRIETARY AND CONFIDENTIAL

THE INFORMATION CONTAINED IN THIS DRAWING IS THE SOLE & EXCLUSIVE PROPERTY OF PLASTICASE INC.
 ANY REPRODUCTION IN PART OR WHOLE WITHOUT THE WRITTEN PERMISSION OF PLASTICASE INC. IS PROHIBITED.

DO NOT SCALE DRAWING
 SHEET SCALE 1:10

Frank Vitiello
 REPRESENTATIVE

David Vidal
 DESIGNER

2023-01-25
 DATE

3/6